



**TOULOUSE
SPACE
SHOW '08**

22 - 25 April, 2008

Pierre Baudis Congress Centre – TOULOUSE

Exhibitor Guide

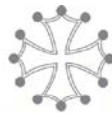

CENTRE DE CONGRÈS
PIERRE BAUDIS
TOULOUSE

Exhibition Manager

Sophie SANGAYRAC

11 Esplanade Compans Caffarelli – 31000 TOULOUSE
Tél. : + 33(0)5 62 30 40 95 - Fax :+33(0)5 62 30 48 49
E-mail : s.sangayrac@centre-congres-toulouse.fr
www.centre-congres-toulouse.fr

Dear Exhibitor,

We have great pleasure in addressing you the Exhibitor's Guide regarding TOULOUSE SPACE SHOW '08 which will be held from 22 to 25 April 2008 in Toulouse, France.

To prepare this exhibition in the best conditions, you will find in this document all the information required for the success of your participation at TOULOUSE SPACE SHOW '08.

We hope this document will help answer any queries you may have.

We would be grateful if you could complete and send us back the order forms enclosed as soon as possible.

We naturally remain at your disposal for any further information you may need.
Looking forward to seeing you in Toulouse,

Best Regards,

SPACE SHOW '08 Exhibition Organizers.

ORGANIZATION TEAM:

Sandrine VARENNE
Executive Director,
Business Conventions International
☎: +33 (1) 41 86 49 49
☎: +33 (1) 46 03 86 26
e.mail: SVarenne@adhes.com
W : www.bciaerospace.com

Le Guellec Jean-Christophe

TOULOUSE SPACE SHOW '08

Executive assistant,
Tel : +33 1 41 86 41 97
e.mail : jcleguellec@adhes.com

CONTENTS

Access map	1
Access transport	2
Exhibition Planning	2
Social Programme	3
Delivery, Storage	3
Practical information	4
Request for information	5
General order form	6
General Conditions	7

Order Forms

Flag sign	8
Floral Decoration	9
Electricity	10
Telephone - Internet	11
Audiovisual Equipment	12
Computing	13
Parking	14
Furniture catalogue	15
Furniture and extra fittings for your stand	16
Instant Lunches	17
Carpet	18
Standalone	19-20
List of agreed Caterer	21

Fire Safety regulations.....22-23

Authorization form24

TRANSPORTS

REGULAR FLIGHTS

High frequency service to Paris; 51 daily return flights to the capital (Orly/Roissy) 55 minutes flying time. 18 airline companies; flights to 34 destinations.

- **National links**

Caen, Carcassonne, Clermont-Ferrand, Lille, Lyon, Marseille, Metz-Nancy, Mulhouse, Nantes, Nice, Paris, Poitiers, Rennes, St-Denis-de-la-Réunion, Strasbourg.

- **International links**

Amsterdam, Basle, Birmingham, Brussels, Casablanca, Dusseldorf, Frankfurt, Geneva, Lisbon, London, Madrid, Milan, Munich, Oran, Porto, Tunis.

ROAD LINKS

Toulouse, located in the Paris-Bordeaux-Montpellier motorway network is intersected by several other motorways : the A62 (to Bordeaux), the A20 (to Paris via Montauban and Limoges), the A61 (to Carcassonne, Montpellier and Barcelona), the A68 (to Albi and Lyon), the A64 (to Tarbes and Lourdes).

Direct access by the Toulouse ring road, exit n° 30 to the town centre.

RAIL LINKS

- Toulouse Matabiau train station
- 15 daily links to Paris including 4 by high speed train to Paris Montparnasse (travelling time 51/2hours).
- 10 minutes from the Conference Centre by car.

CONTACT AT PIERRE BAUDIS CENTRE

EURL SECCPB

Exhibition Manager :

Sophie SANGAYRAC - Tél. : +33 (0)5 62 30 40 95.

Email : s.sangayrac@centre-congres-toulouse.fr

11, Esplanade Compans Cafarelli – 31000 Toulouse - FRANCE

EXHIBITION PLANNING

	DATES	HOURS
Exhibition setting up	Saturday 19 th April	8.00 am to 6.00 pm
	Sunday 20 th April	8.00 am to 6.00 pm
Exhibitors setting up	Monday 21 st April	9.00 am to 6.00 pm
Exhibition opening hours	Tuesday 22 nd April	10.00 am to 9.00 pm
	Wednesday 23 rd April	9.00 am to 6.00 pm
	Thursday 24 th April	9.00 am to 6.00 pm
	Friday 25 th April	9.00 am to 4.00 pm
Dismantling	Friday 25 th April	4.00 pm to 10.00 pm

Exhibition Area **Level -1 Room Concorde**
Ground floor Caravelle 2

Tuesday 22 April 2008

Icebreaker

Cocktails will be offered to all participants on Tuesday 22 April 2008, following the inaugural ceremony of the Toulouse Space Show; and the icebreaker will take place in the centre of the exhibition at the Centre de Congrès Pierre Baudis.

Wednesday 23 April 2008

Gala evening (no included in the Exhibitor Pass)

The Cité de l'Espace in Toulouse will be hosting the gala evening for the Toulouse Space Show.

<http://www.cite-espace.com>

Refreshed with cocktails and a variety of tasty French specialities, you can then wander through the Cité de l'Espace to see the exhibitions and life-size spacecraft models in the park outside, but also to attend a show at the planetarium and enjoy a 3-D film at the Imax® cinema.

Your Booth and Equipment

Access to the site/Setting up the exhibition

According to your registration you will be provided with the following equipment :

1/ Bare Surface : Floor only (you have to order furniture)

LIGN'EXPO

<http://www.lignexpo.com/>

Phone : +33 (0)5 62 75 99 30 - Fax : +33 (0)5 62 75 99 39

- For exhibitors with bare surface: from Saturday 19th April
- For exhibitors with shell scheme: from Monday 21st April from 9am

This should give you enough time to settle yourself and display your products and brochures.

2/ Shell Scheme booths :

Carpet

Walls

Fascia name

Furniture (1 table, 3 chairs and 1 wastebasket)

Electricity (3 electrical box : 1.5kw with 3 spots)

Daily cleaning

DELIVERY, STORAGE

- ❖ All the parcels must comprise the exact co-ordinates of the shipper, the heading and the dates of the congress.
- ❖ All the particular parcels (fragile, very cumbersome...) must be announced before sending to the Centre of Congress to the attention of the Exhibition Manager: Sophie SANGAYRAC
Phone + 33 (0) 5 62 30 40 95 E-mail : s.sangayrac@centre-congres-toulouse.fr

For the possible storage of box boards, the exhibitor is held to make contact on the spot with the Exhibition Manger in order to determine a space where those will be stored. If necessary, all the packing will be removed and thrown at the time of final cleaning before the official opening of the exhibition.

Access to the delivery surface of the Congress centre Pierre Baudis:

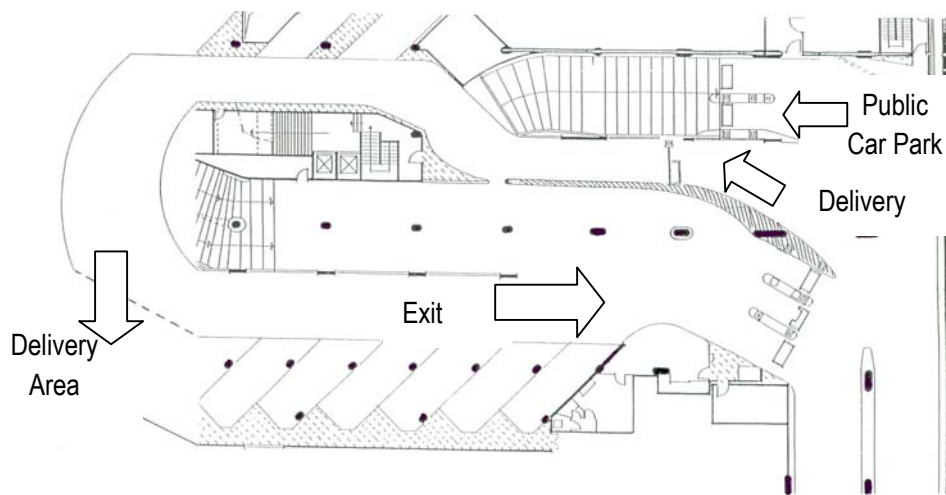

Access to the delivery area of the Conference Centre

The delivery and unloading area can be reached via the public car parking « Compans Caffarelli » which entrance is located on Boulevard Lascrosses.

The size of the vehicles should not exceed:

- Height : 2,95 m
- Length : 12 m
- Maximum weight: 13 tons

The exhibitors (or drivers) whose vehicles exceed the above-mentioned dimensions have to park along the Boulevard Lascrosses (in front of Esplanade Compans Cafarrelli) and load or unload with a (lift) truck (The distance is approx. 50 m).

Access to the Delivery Area will be available during the mounting and dismantling periods.

Saturday 19th April 08 7.00 am to 7.00 pm

Sunday 20th April 08 7.00 am to 7.00 pm

Monday 21st April 08 7.00 am to 7.00 pm

In order to reach the exhibition area, the exhibitor is kindly requested to use the elevator accessible from the Delivery Area.

Parking is free of charge for the first half hour only.

The technical team of the Conference Center and the person in charge will be on the site during the mounting and dismantling phases, in order to see to all the details.

DELIVERY

No deliveries will be accepted before the 1st setting up

As the delivery area does not have an unloading bay, it is preferable for Lorries (trucks) to be equipped with tailgates.

Equipment unloading time: 30 minutes

Delivery on setting up day.

Any delivery made directly by a haulage contractor to the Pierre Baudis Congress Center will only be accepted on the exhibitor's set up day and in the presence of a person in charge of the stand.

Delivery is carried out under the exhibitor's responsibility. Under no circumstances can the Toulouse Convention Center be held responsible.

Any equipment delivered to the Toulouse Convention Center should clearly indicate.

The Toulouse Convention Center Address

The name of the event

The name of the stand, the person in charge and his/her telephone number.

✓ Material delivery :

We are glad to inform you that the company **WEL** is the official carrier for the exhibition.

Feel free to contact **WEL** directly with your instructions and all necessary information and documents (purchase of order).

Contact :

WEL – Patrick REJAUD - +33 (0)1 64 27 21 17

Patrick.rejaud@wel.fr

STORAGE

For security reasons, any empty boxes must be removed from within the Pierre Baudis Congress Center since there is no space set aside for this purpose. Any empty boxes or other packaging material found in the hall will be destroyed.

RETURN OF PACKAGES

Any package or object left behind after the exhibition in the Pierre Baudis Congress Center which has not been left in the storage area is not the responsibility of the exhibition organizers. The Convention Center is no way responsible for the disappearance or destruction of any such packages.

EARLY DELIVERY AND EMPTY CONTAINERS STORAGE

Outside of the exhibition preparation period, please contact the following company

✓ Material delivery :

We are glad to inform you that the company **WEL** is the official carrier for the exhibition.

Feel free to contact **WEL** directly with your instructions and all necessary information and documents (purchase of order).

Contact :

WEL – Patrick REJAUD - +33 (0)1 64 27 21 17

Patrick.rejaud@wel.fr

For a fee, this company will store between delivery date and the day the booths are set up and will deliver your goods to the booth for set up. The company can also store the empty containers during the exhibition.

VAT REIMBURSEMENT FOR FOREIGN EXHIBITORS

Foreign exhibitors can request reimbursement of the VAT on the invoices addressed by the Pierre Baudis Congress Center by sending the original invoices to the tax authorities within a month following the event to the following address:

LA DIRECTION GENERALE DES IMPOTS

Service de remboursement de la TVA

9, rue d'Uzès

75084 PARIS CEDEX 02

FRANCE

TEL : +33 (0)1 44 76 18 00

or to a fiscal representative liable for tax set up in France who undertakes to fulfil the obligations incumbent upon him/her.

Easytax society for more information:<http://www.easytax.fr>

REQUEST FOR INFORMATION TO FORWARD TO YOUR STAND BUILDER TO RETURN US IMPERATIVELY

The Congres Centre Pierre Baudis is pleased to welcome you.

To make work easier for everybody, I thank you in advance to return this document, filled out , to our exhibitors department by fax to : + 33 5 62 30 48 49.

Name of of the exhibition :
.....

Name of the booth on which you are working n° 1 :

Name of the booth on which you are working n° 2 :

Name of the booth on which you are working n° 3 :

Name of your Company :

Address :

Phone :

Fax :

Contact on site :

Mobile :

Arrival for set-up at :

Number of vehicle :/Type of vehicle : Immatriculation.....

Set-up timing :

Timing for dismantling:

Number of vehicle :/ Type of vehicle : Immatriculation.....

Be careful: This document **MUST REACH US** 10 days before your arrival
If not, you would **not be able to** access our loading bay

TECHNICAL INSTRUCTIONS FOR SET-UP AND DISMANTLING

YOUR ACCESS TO THE LOADING BAY WILL BE POSSIBLE AS SOON AS ALL EXHIBITORS HAVE LEFT THE EXHIBITION AREA

- You dismantle your installation
- Loading of your vehicle is made on your own
- You leave the Venue

ACCESS TO THE LOADING BAY IS ON YOUR OWN CHARGE

For more information please contact our exhibitors' department : +33 5.62.30.40.95.

GENERAL TERMS OF SALE

The Taker's Obligations

The Taker has the sole responsibility for his event as far as the participants, the exhibitors, the service providers commissioned by him, the visitors or guests, and also the Vendor are concerned, and it will be his responsibility to ensure that the provisions laid out in the present document are observed and advertised.

Consequently, the Taker must ensure that the object of his event complies with the current legislation and regulations in force. The Taker will personally make sure that the authorisations required to hold his event are obtained and more specifically, although this list is not exhaustive, those required for the sale of alcoholic or non-alcoholic drinks, the delayed opening of the event and for playing music by making the necessary declarations at the SACEM, for free access to rights concerning intellectual property, marks and brands etc...., used in the framework of this event.

The Taker must justify this in writing to the Company EURL SECCPB, at least one month prior to the opening of the event and the granting of these authorisations.

The Taker shall be held fully liable, both in terms of criminal and civil liability, for the possible consequences arising from a lack of authorisation, without the Company EURL SECCPB being able to be held liable for any given reason.

He shall also relieve the Company EURL SECCPB of any injurious consequences which could result for the latter, and cover these consequences, arising from non-compliance with the aforementioned provisions.

Furthermore, the Vendor reserves the option to expel the Taker from his premises if the object of his event does not concur with that which was stated upon signature of the contract(s).

1. The Vendor's Obligations

The Vendor guarantees that his premises and provision of additional services comply with the signed contract(s).

Prior to making any use of said provision, the Taker must satisfy himself of this conformity. No claim may be formulated once the equipment has been used or services performed.

The premises shall be made available to the Taker in perfect condition and working order. Any damage discovered after the holding of the event will be invoiced to the Taker. A counter inventory of the premises may be held before and after the event at the Vendor's request.

2. Provision of services

Given the imbrication of the network in the building, the high knowledge he has of the building itself as well as its facilities and installations, the Vendor is the exclusive provider for the Taker of the following services:

- the electricity supply
- telecommunications
- water supply
- cleaning
- security.

The Taker is under obligation to entrust the provision of catering and/or bar services within the TOULOUSE CONVENTION CENTER to the Vendor himself.

3. Use of the Vendor's logo

The Vendor will make available to the Taker the elements required to reproduce his logo. Authorisation for said reproduction shall be solely for the contractually stated event and taking place at the Convention Center of Toulouse. Any other use of the name "Centre de Congrès Pierre Baudis" outside the contractually stated event and the supplied logo will be subjected to prior written request on the part of the Taker and a written authorisation by the Vendor.

4. Invitations and Privilege Cards

The Taker undertakes to submit to the Vendor a batch of 25 invitations for the events that are open to the **general public**.

More over, except under exceptional circumstances, the Taker undertakes to admit holders of the Congress Center Privilege Card, that gives them free access to all the events that are held at the Convention Center of Toulouse.

5. Disputes, choice of residence

The COMMERCIAL COURT OF TOULOUSE SHALL BE THE SOLE COURT OF COMPETENT JURISDICTION for any contest arising as a result of the present contract or its repercussions. This express allocation of competence is equally valid in the case of several defendants and for all claims, even incidental, in intervention or appeal in guarantee.

The contracts drawn up between the Vendor and the Taker are governed by French law and only the French version of the contractual documents is authentic.

Dated:

Compulsory Signature:

TOULOUSE SPACE SHOW'08

April 22-25, 2008

PIERRE BAUDIS CONGRESS CENTRE - TOULOUSE

FLAG SIGN

PLEASE RETURN TO THE Pierre BAUDIS
CONGRESS CENTRE

Please return before April 4th, 2008

Exhibitor:

This sign will show the name of your company and your booth number.

It will be fixed on the separating partition or on a baluster, depending on the shape of booth.

You must return this page whatever your requirements.

1	2	3	4	5	6	7	8	9	10	11	12	13	14	15	16	17	18	

The characters are standardized and printed out in capitals

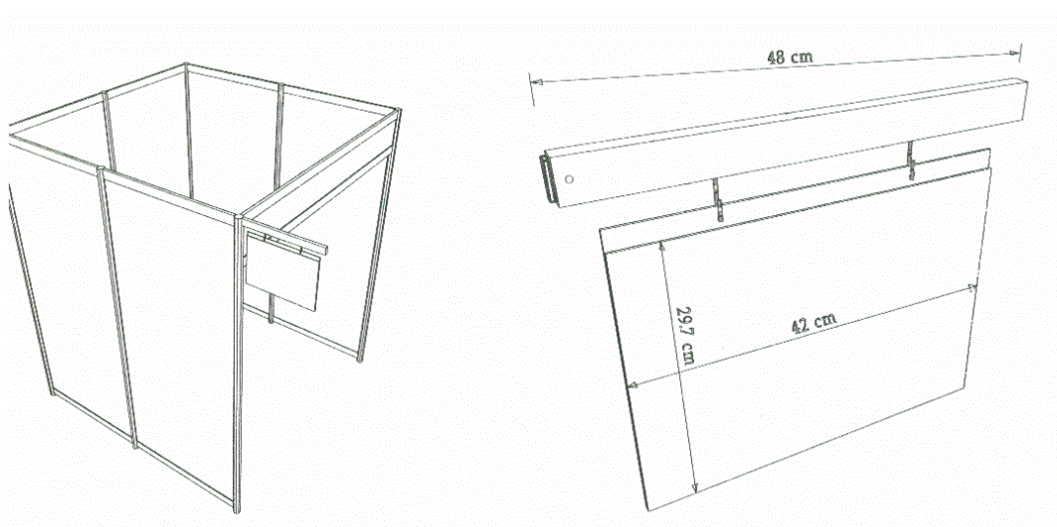

Sophie SANGAYRAC

Centre de Congres Pierre Baudis

11 Esplanade Compans Caffarelli – 31000 TOULOUSE - FRANCE

Tél. : +33 (0)5 62 30 40 95 - Fax : +33 (0)5 62 30 48 49

E-mail : s.sangayrac@centre-congres-toulouse.fr

TOULOUSE SPACE SHOW'08

April 22-25, 2008

Pierre BAUDIS CONGRESS CENTRE







FLOWER DECORATION ❶

ORDER FORM

PLEASE RETURN TO THE Pierre BAUDIS
CONGRESS CENTRE

Please return before April 4th, 2008

Exhibitor :

	DESCRIPTION	QUANTITY	UNIT PRICE €	Total price
	Floral composition n°1 Diam. 20 cm		50,00 €	
	Floral composition n°2 Diam. 20 cm		65,00 €	
	Rectangular Composition 50 x 20 cm		80,00 €	
	Rectangular Composition 100 x 20 cm		95,00 €	
	Ficus H. 150 / 180 cm		85,00 €	
	Rectangular Composition H. 150 – 80 x 35 cm		140,00 €	
			TOTAL (excl VAT) €	
			19,60 % VAT	
			TOTAL (inclusive VAT) €	

To refer to Total including VAT ❶ page 6

DATE & SIGNATURE :

COMPANY STAMP :

SPACE SHOW'08

April 22-25, 2008

Pierre BAUDIS CONGRESS CENTRE

ELECTRICITY ②

ORDER FORM

PLEASE RETURN TO THE Pierre BAUDIS
CONGRESS CENTRE

Please return before April 4th, 2008

Exhibitor:

1.5 Kw is already included in your booth

DESCRIPTION	UNIT PRICE € Exc.VAT	QUANTITY	Total price
Additional 1,5 Kw Mono	133.00 €		
Additional 3 Kw Mono	195.00 €		
Additional 5 Kw Mono	267.00 €		
Additional 10 Kw Mono	305.00 €		
Additional tip of spots	60.00 €		
Multi-plug	5.60 €		
TOTAL (excl VAT) €			
19.60 % VAT			
TOTAL(including VAT) €			

To refer to Total including VAT ② page 6

Practical hints

DESIGNATION	POWER USED	For example :
3 spots	0,3 KW	2 spots : 2 x 0.1 kw = 0.2 kw
1 Halogen	0,3 KW	1 computer : 1 x 0.5 kw = 0.5 kw
1 Computer	0,5 KW	1 coffee machine : 1.5 kw = 1.5 kw
1 Coffee machine	0,8 to 4 KW	You need : 3 kw
1 Fridge	0,2 KW	

DATE & SIGNATURE :

COMPANY STAMP :

Sophie SANGAYRAC
Centre de Congres Pierre Baudis
11 Esplanade Compans Caffarelli – 31000 TOULOUSE - FRANCE
Tél. : +33 (0)5 62 30 40 95 - Fax : +33 (0)5 62 30 48 49
E-mail : s.sangayrac@centre-congres-toulouse.fr

TOULOUSE SPACE SHOW'08

April 22-25, 2008

Pierre BAUDIS CONGRESS CENTRE

TELEPHONE-INTERNET ③

ORDER FORM

**PLEASE RETURN TO THE Pierre BAUDIS
CONGRESS CENTRE**

Please return before April 4th, 2008

WIFI IS ON DURING THE EXHIBITION

Exhibitor:

N°	DESCRIPTION	QUANTITY	UNIT PRICE € Excl. VAT	Total price
1	Digital line Phone only 150 impulses		126.60 €	
2	Analog line for fax or internet access		133.25 €	
3	ISDN Line Internet Access 150 impulses		185.55 €	
4	ADSL line 1024K/256K Unlimited		399.25 €	
			TOTAL€	
			19,60 % VAT	
			TOTAL (including VAT) €	

To refer to Total including VAT ③ page 6

DATE & SIGNATURE :

COMPANY STAMP :

Sophie SANGAYRAC
Centre de Congres Pierre Baudis
11 Esplanade Compans Caffarelli – 31000 TOULOUSE - FRANCE
Tél. : +33 (0)5 62 30 40 95 - Fax : +33 (0)5 62 30 48 49
E-Mail : s.sangayrac@centre-congres-toulouse.fr

TOULOUSE SPACE SHOW'08

April 22-25, 2008

Pierre BAUDIS CONGRESS CENTRE



AUDIOVISUAL ④

ORDER FORM

PLEASE RETURN TO THE Pierre BAUDIS
CONGRESS CENTRE

Please return before April 4th, 2008

Exhibitor :

N°	DESCRIPTION	PICTURE	UNIT PRICE € Exc. VAT	QUANTITY	X COEFFICIENT	TOTAL
1	Screen LCD		250,00 €			
2	VCR VHS		46.10 €			
3	TV with built in VHS VCR		180,00 €			
4	Slide Projector		94,00 €			
5	Screen 180 cm x 180 cm		74,00 €			
6	Video projector 2200 lumens		350.00 €			
7	Plasma screen with Foot Scaraber		515.00 €			
					TOTAL (excl VAT)	
					€	
To refer to Total including VAT ④ page 6					19,60 % VAT	
DATE & SIGNATURE :					TOTAL including VAT €	
COMPANY STAMP :						

Number of day	2	3	4
---------------	---	---	---

Coefficient	1.5	2	2.5
-------------	-----	---	-----

TOULOUSE SPACE SHOW'08

April 22-25, 2008

Pierre BAUDIS CONGRESS CENTRE

COMPUTING 5

ORDER FORM

PLEASE RETURN TO THE Pierre BAUDIS
CONGRESS CENTRE

Please return before April 4th, 2008

Exposant :

Modèle	DESCRIPTION	UNIT PRICE € Exc. VAT 1 DAY	UNIT PRICE € Exc. VAT 2 DAYS	UNIT PRICE € Exc. VAT 3 DAYS	UNIT PRICE € Exc. VAT 4 DAYS	QUANTITY	Total price € Exc. VAT
Pack desktop computer	Compaq PIV 3Ghz 512Mo-DD80Go –CD – Intel Ethernet Windows XP & Office XP Ecran LCD 19"	245.00	270.00	285.00	300.00		
Pack desktop computer + printer B&W A4	Compaq PIV 3Ghz 512Mo-DD80Go –CD – Intel Ethernet Windows XP & OfficeXP Ecran LCD 19" avecimprimante laser N&B A4	350.00	385.00	410.00	435.00		
Pack desktop computer + laserjet color printer A4	Compaq PIV 3Ghz 512Mo-DD80Go –CD – Intel Ethernet Windows XP & Office XP Ecran LCD 19" laser couleur A4	455.00	495.00	525.00	545.00		
Pack PC portable	Pentium Centrino 1.8 Ghz – Toshiba Tecra A2 – 512 Mo – DD 60 go – Superdrive – son –Ecran 15" TFT – Ethernet – Windows XP – Pack office XP -	320.00	340.00	360.00	370.00		
Pack Imac	Imac G5 1.8 Ghz – Ecran LCD 17 768 MO- DD80 Go DVDR / CDRW Geforce FX5200 – Ethernet – Airport Mac OSX – Pack Office 2001	300.00	315.00	330.00	340.00		
Pack Bornes Interactives Tactiles	Compaq PIV 2.8 Ghz 512Mo-DD40Go –CD – Intel Ethernet Windows XP & Office XP Ecran LCD 17"	665.00	725.00	770.00	800.00		
Pack Ecran LCD	Ecran 20 " LCD 1280 X 1024	150.00	160.00	170.00	185.00		
TOTAL(excl .VAT)							
19,60 % VAT							
TOTAL including VAT €							

To refer to Total including VAT 5 page 6

TOULOUSE SPACE SHOW'08

April 22-25, 2008

Pierre BAUDIS CONGRESS CENTRE

PARKING ⑥

PLEASE RETURN TO THE Pierre BAUDIS
CONGRESS CENTRE

Please return before April 4th, 2008

Exhibitor :

DESCRIPTION	UNIT PRICE € Exc. VAT	QUANTITY	Total price
Park ticket for 2 days	24.50 €		
Park ticket for 3 days	36.50 €		
Park ticket for 4 days	49.00 €		
Park ticket for 5 days	61.00 €		
Park ticket for 6 days	73.00 €		
			TOTAL(excl VAT) €
			19,60 % VAT
			TOTAL (including VAT) €

To report Total including VAT ⑥ page 6

Parking spaces will be allocated subject to availability.

Parking Ticket : X entrances & X exit

Parking ticket will be given to you at the time of your installation

DATE & SIGNATURE :

COMPANY STAMP :

Sophie SANGAYRAC
Centre de Congres Pierre Baudis
11 Esplanade Compans Caffarelli – 31000 TOULOUSE - FRANCE
Tél. : +33 (0)5 62 30 40 95 - Fax : +33 (0)5 62 30 48 49
E-mail : s.sangayrac@centre-congres-toulouse.fr

TOULOUSE SPACE SHOW'08

April 22-25, 2008

Pierre BAUDIS CONGRESS CENTRE

FURNITURE AND EXTRA FITTING FOR YOUR STAND 7

ORDER FORM

RETURN TO THE CONVENTION CENTER

Pierre BAUDIS

Please return before April 4th, 2008

Exhibitor :

1 table + 2 chairs are already included in your booth

N°	DESCRIPTION	QUANTITY	UNIT PRICE € Exc. VAT	Total price
1	1 Table + 3 chairs		28.70 €	
2	1 Table		18.05 €	
3	1 Chair		5.00 €	
4	Storage area 1 sq.m		184.40 €	
5	Storage area 2 sq.m		226.30 €	
6	Storage area 3 sq.m		269.40 €	
			TOTAL before VAT €	
			19,60 % VAT	
			TOTAL including VAT €	

To report Total including VAT 7 page 6

DATE & SIGNATURE :

COMPANY STAMP :

Sophie SANGAYRAC
Centre de Congres Pierre Baudis
11 Esplanade Compans Caffarelli – 31000 TOULOUSE - FRANCE
Tél. : +33 (0)5 62 30 40 95 - Fax : +33 (0)5 62 30 48 49
E-mail : s.sangayrac@centre-congres-toulouse.fr

TOULOUSE SPACE SHOW'08

April 22-25, 2008

Pierre BAUDIS CONGRESS CENTRE

CARPET 8

ORDER FORM

RETURN TO THE CONVENTION CENTER

Pierre BAUDIS

Please return before April 4th, 2008

Exhibitor :

Blue carpet is already included in your booth

DESCRIPTION	QUANTITY m ²	UNIT PRICE € Exc. VAT	Total price
Red ref. 3912		10.00€	
Blue ref. 3824		10.00€	
Grey réf. 3985		10.00€	
Black réf. 3910		10.00€	
Dark Grey réf. 3965		10.00€	
Orange réf. 39107		10.00€	
Green réf. 3901		10.00€	
Purple réf 3939		10.00€	
		TOTAL before VAT €	
		19,60 % VAT	
		TOTAL including VAT €	

To report Total including VAT 8 page 6





SUPPLIER INFORMATION

COMPRESSED AIR SUPPLIER

Measurement relating to the public health

The compressors installed inside the buildings must function exclusively with the electric power and to have a bearable noise by the exhibitors and the visitors.

The thermal and noisy compressors are prohibited inside a building.



KILOUTOU :
14 allée Pablo Picasso
RN-20 C.Cial Carrefour
31120 PORTET SUR GARONNE

Tél.00 33 05 61 76 36 78



LOXAM :
Bd Courties
31120 PORTET SUR GARONNE

Tél.00 33 05 61 72 33 77

LIST OF AGREED CATERERS BY THE CONGRESS CENTER OF TOULOUSE

- | | | |
|---|---|--|
| 1. GIMM TRAITEUR | Monsieur Gérard CALVET
4, rue du CASSE
31240 SAINT JEAN | Tél : 05 62 89 20 20
Fax : 05 62 89 20 21 |
| 2. FALCOU TRAITEUR | Monsieur Marceau FALCOU
15, rue du CASSE
31240 SAINT JEAN | Tél : 05 62 89 04 70
Fax : 05 62 89 10 72 |
| 3. BENAC TRAITEUR | Monsieur Pascal BENAC
46, rue des CARMES
31310 MONTSQUIEU-VOLVESTRE | Tél : 05 61 90 43 64
Fax : 05 61 90 39 52 |
| 4. BLANC TRAITEUR | Monsieur Philippe BLANC
10, impasse de CANDIE
31100 TOULOUSE | Tél : 05 61 07 58 98
Fax : 05 61 06 70 14 |
| 5. PAVILLON D'OC TRAITEUR
Sarl TFG | Monsieur Thibault FERNANDEZ
101, rue Edouard ROSTANT
31200 TOULOUSE | Tél : 05 34 40 06 90
Fax : 05 61 47 35 83 |
| 6. C & N TRAITEUR | Mr et Mme FAIDHERBE
9, rue de LOEWY
Parc de GRATIAN
31140 AUCAMVILLE | Tél : 05 61 37 10 10
Fax : 05 62 10 75 40 |
| 7. SKANDINAVIAN | Mr Tina BLACK
54 Chemin Quilla
31190 AUTERIVE | Tél : 05 34 27 10 38
Fax : 05 34 28 09 65 |

FIRE SAFETY REGULATIONS

1. The obligations of the exhibitors

Exhibitors are obliged to strictly adhere to the provisions of the safety regulations and those specific to the event, detailed in the schedule of conditions given to them by the organiser.

The layout work must be complete at the time of the approval visit by the safety manager (in the case of a standard layout) or at the time of the visit from the Commission Départementale de Sécurité (in the case of a different layout). The exhibitor must take all measures to ensure that these layouts, fixtures and features can be examined in detail.

The exhibitor or his qualified representative must be present during this approval visit. He must make available to the safety manager and/or the members of the Commission Départementale de Sécurité all information concerning the installations and materials comprising the stand, except for those covered by a recognised quality mark.

The exhibitor must submit any special authorisation requests or special declarations to the safety manager or to the Prefect within the deadlines mentioned in paragraphs 1.1 to 1.1.3.

1.1 Stand layout

1.1.1 Protecting the structure

The access routes, circulation walkways and areas used for the transportation of equipment from the unloading point to the event site must be protected:

- ° Use of forklifts or other handling equipment with rubberised treads
 - ° Use of weight distribution boards
 - ° Carpets must be protected by a highly resistant covering in order to avoid puncturing
- No means of attachment that risks damaging the room surfaces (floors, walls, posts or ceilings) will be allowed.

1.1.2 Frames and partitions

All materials with a M0, M1, M2 and M3 rating are authorised for the construction of the frameworks and partitioning on stands.

In accordance with the decree dated 30 June 1983, the formal classification of wood-based materials states that the following are considered to meet to the characteristics of materials classification M3:

- ° Solid, non-resinous wood with a thickness in excess of or equal to 14 mm
- ° Solid resinous wood, with a thickness in excess of or equal to 18 mm.
- ° Wood-based panels (chipboard, plywood, etc) with a thickness in excess of or equal to 18 mm

1.1.3 Extending, sliding or removable partitions

Extending, sliding or removable partitions must have an M3 rating

1.1.4 Wall coverings

Coverings (natural or plastic textiles) with a M0, M1, M2 rating may be used. These must be taut and should be secured using staples.

Miscellaneous coverings (fabrics, paper, plastic film, etc) which are slightly or easily flammable, and which are thin (maximum 1 mm), must be glued onto solid M0, M1, M2 or M3 surfaces.

In all cases, the following are forbidden within the Congress Center :

- ° Soft cellulosic chipboard
- ° Boards, panels or sheets of expanded plastic materials which do not have at least an M2 rating.
- ° Coverings which are not rated at least M2

1.1.5 Floor coverings

Floor coverings must be produced from materials with a rating of at least M4 and solidly attached. However, for those coverings (horizontal and vertical) with a total surface area in excess of 20 m², and for podiums, platforms and tiered terraces with a height in excess of 0.30 m, these must be at least category M3.

1.1.6 Curtains, drapes and veils

Curtains, drapes and veils may be "flowing" if they have a classification of M0, M1 or M2. They are however forbidden for all entrance doors to stands, but are allowed on the doors of booths.

The materials exhibited may be shown without any fire reaction requirements, except if they are used to decorate partitions or false ceilings, and if their total surface area exceeds 20% of the total surface area of these structures.

In this case, they must observe the requirements detailed in the paragraphs above for partitions, and of the paragraph below for canopies, ceilings and false ceilings.

However, these provisions do not apply to shows and stands specific to interior decoration in which textiles and wall coverings are present.

1.1.7 Canopies, ceilings and false ceilings

Canopies must be produced from materials rated M0 or M1. They must moreover be supported by a wire mesh structure, with squares of a maximum of 1 m x 1 m.

Ceilings and false ceilings must be produced from M0 or M1 rated materials.

These features must not hinder the correct operation of the fire detection and smoke removal installations.

1.1.8 Floral decorations

Floral decorations produced from synthetic materials must be kept to a minimum. Otherwise, the decorations must be produced from category M2 materials

These provisions do not apply to shows and stands specialising in floral activities.

1.1.9 "Flowing" decorative features

"Flowing" decorative features or coverings (advertising material with a surface area in excess of 0.50m², garlands, bunting, lightweight decorative items, etc) must be produced from M0 or M1 rated materials or made as such through fireproofing.

The use of signs or advertising panels involving white letters on a green background is strictly forbidden. These colours are exclusively reserved for the signposting of "exits" and of "emergency exits".

1.1.10 Furniture

There are no special requirements for normal furniture (tables, chairs, desks etc).

1.1.11 Fire reaction certificates

All materials used should be covered by a fire reaction certificate issued by an approved French laboratory, and dating from at least during the last five years.

So-called "traditional" materials and materials covered by a quality mark from a certification issuing body (NF, etc) are excluded from this obligation.

Where fireproofing is concerned, this can only be carried out on wooden panels, natural fabrics or fabrics including a high proportion of natural fibres. It cannot be carried out on plastic or synthetic materials. The fireproofing certificate is supplied by the company or organisation applying the treatment, stipulating the authorisation granted to it to issue such a document.

1.1.12 The presence of a marquee, a tent or other removable structures.

If, during an event, it is planned to use a marquee, a tent or similar structure on a stand, the organiser must ensure that the exhibitor observes the safety provisions detailed in CTS 1 to CTS 37 (excluding CTS 5).

Under no circumstances should this temporary structure hinder the effectiveness of the technical facilities of the establishment, with respect to the safety of the staff and the public.

1.1.13 Enclosed stands

In the case of enclosed stands, the latter must have direct outlets onto the walkways. Their number and width vary according to the surface area of the stand, and as a minimum the following requirements should be observed:

- ° less than 20 m² : 1 exit of 0.90 m
- ° from 20 to 50 m² : 2 exits : one of 0.90 m, the other of 0.60 m.
- ° from 50 to 100 m² : either 2 exits of 0.90 m
or 2 exits, one of 1.40 m, the other of 0.60 m
- ° from 100 to 200 m² : either 2 exits, one of 1.40 m, the other of 0.90 m or 3 exits of 0.90 m.
- ° from 200 to 300 m² : 2 exits of 1.40 m
- ° from 300 to 400 m² : 2 exits, one of 1.40 m, the other 1.80 m

The exits must be carefully located and if possible opposite (facing) one another.

Each of these must be signposted with the wording "SORTIE" (in English = EXIT) in white letters on a green background.

If the stand is enclosed by doors, these must open in the direction of the exit, with no means of locking them, and without opening on the public walkway.

If the stand is covered, the provisions of article

1.1.14 here after must be observed.

1.1.14 Covered stands/ Raised stands

Those stands possessing a ceiling, false ceiling or solid canopy, as well as raised stands, must:

- ° have a surface area below 300 m²
- ° have a distance between them equal to or in excess of 4 m
- ° Have a total size for the ceiling and false ceiling (including those of the upper levels) equal to a maximum of 10% of the surface area of the level concerned.

Each stand may have only one raised level.

If the surface area of the stand is in excess of 50 m², it must:

- ° feature signposting with standalone emergency lighting indicating the exits,

- ° be equipped with the appropriate means of extinction, permanently manned by at least one safety officer during the presence of the public in the establishment
- ° have floodlighting if the surface area is in excess of 100 m²

1.2 Electrical installations

1.2.1 Limits of liability

Electrical installations include:

- ° Fixed and semi-permanent installations, for which the installation, operation and maintenance are carried out by the agent, at his liability.
- ° Installations fitted in the stands for the use of the exhibitors and installed by them, or on their behalf, and at their liability.

The dividing line between these two installations is considered to be at the service box 1 for each stand.

In conformity with article T35 of the decree dated 18 November 1987, supplementing the decree dated 25 June 1980 (modified). Semi-permanent installations must terminate in each stand at a panel or service box 1 which includes the switchgear to provide the control and protection functions defined in this article.

Therefore, this formally excludes the possibility of connecting several stands from a single box or from a single panel

1.2.2 Special stand installations

The special installations of the stands must be produced by personnel particularly aware of the special risks inherent to the event, and possessing sufficient knowledge to enable them to design and carry out the work in conformity with the present regulations.

The electrical installation for each stand must be protected at its source against overloads and against earth faults.

All metal grounds must be interconnected and linked to the earth wire of the electrical service box 1 on the stand.

Electrical connections must be located inside the branch boxes

Electrical cut-off features included in the service box 1 must be permanently accessible to the stand personnel.

1.2.3 Electrical equipment

All electrical equipment must conform to French or European standards.

1.2.4 Electrical cabling

Electrical cables must be insulated for a minimum nominal voltage of 500 volts, which rules out among others H 03 VHH cable (Scindex).

The cable used must obligatorily be that for which each conductor features its own protective sheath, with all of the conductors being contained in a joint protective sheath.

Conductors with a gauge below 1.5 mm² are forbidden

All cabling must include a protective conductor connected to the terminal of the service box connected to the general earth network.

1.2.5 Switchgear and controlgear

Class 0 devices should be protected by nominal differential current devices equal to a maximum of 30mA.

Class 1 devices must be connected to the protective conductor of the cable feeding them.

The use of individual protective earth connections is forbidden.

High voltage discharge lamps must be installed in conformity with the rules of standard NF C 15.150. If they are enclosed in insulating jackets, these jackets must be comprised of category M3 materials

The switch detailed in article 5 of NF C 15.150 can be attached to the control device mentioned in article T 35 (§3) for the corresponding stand.

Plug sockets must be connected to circuits including devices for the protection of rated current overloads equal to a maximum of 16A.

Notwithstanding the provisions of article EL 6 (§5), the use of a multiple adapter or a multiple housing fed from a fixed socket is authorised (with current taps being forbidden).

1.2.6 Illuminated signs

Class 2 spotlights (NF standard C 20.030) are the only ones permitted.

High voltage illuminated signs located within reach of the public or of personnel working on the stand must be protected, in particular the electrodes, by a screen made from at least M2 grade material.

The emergency cutout control must be clearly signposted and the transformers located in an area which presents no danger to the public or to staff. If necessary, indicate their presence with a sign marked "DANGER HAUTE TENSION" (DANGER HIGH VOLTAGE)

1.3 Flammable liquids and gases

1.3.1 Authorized liquids

The use of particularly flammable liquids (diethyl ether, carbon disulphide, etc.), is forbidden, and only the use of category 1 flammable liquids (up to a maximum limit of 5 litres per stand) is authorised, in addition to those of category 2, limited to 10 litres/10 m² (with a maximum of 80 litres).

For information, petrol falls under category 1, heating oil and alcohol substances between 40° and 60° GL are in category 2.

The following precautions should be taken:

- ° Fire extinguishers should be kept nearby (with 9 kg of powder)
- ° Underneath the tanks, a watertight receptacle should be placed which is able to contain if necessary all of the combustible liquid in the event of a leak.
- ° The device containing liquid should be refilled well away from the public.

1.3.2 Showing flammable products

All recipients of flammable liquids present on the stands must be empty (paint tins, varnish tins, bottles, sprays, etc) with the exception of a few samples in limited quantities.

1.3.3 Compressed gases and liquefied hydrocarbons

The use of these products is only allowed for the special requirements of those demonstrations carried out within the framework and theme of a special event.

Bottles of air, nitrogen and CO² gas are allowed without restrictions.

Compressed gases and liquefied hydrocarbons may be allowed (bottle of 13 kg maximum)

Bottles without pressure regulators which are not used for demonstration purposes are forbidden.

Bottles in the process of being used should always be placed well away from the public and should be protected against impacts.

These must be:

- ° either separated from one another by a rigid and fireproof screen, and dispersed at a density of one bottle per 10 m² (at least), with a maximum of six per stand.
- ° or be at least 5 m away from one other, with a maximum of six per stand.

No bottle (empty or full) which is not connected may be stored inside the establishment.

The bottles must be either upright or laid down on the ground taking care to rest the head on a support of some kind to ensure that it is slightly tilting, with the tap uppermost.

Bottles of oxygen, hydrogen or acetylene are forbidden, except in the event of a special dispensation being granted by the manager of the Palais des Congrès.

1.3.4 Fireworks and similar devices

All fireworks and similar effects generating audible detonations, sparks, flames or smoke are strictly forbidden.

The use of carbon dioxide (CO₂) to create smoke effects must be the subject of a special request to the manager of the Palais des Congrès.

1.4 Machines and devices in operation

If machines are to be shown running, a protected area must keep the public at least 1 m from these machines. This distance may be increased if the safety manager considers this necessary, according to the risk noted.

Moving parts, hot surfaces, and/or sharp or cutting protrusions must be protected by a rigid screen, or placed at least 1 m back from walkways or areas accessible to the public.

Hydraulic safety devices for machines shown in the upright static position must be supplemented by a mechanical device to prevent sudden telescoping.

All equipment exhibited must be correctly secured in order to avoid any risk of it toppling.

1.4.1 Machines with heat or combustion engines, and motor vehicles

Exhaust gases must be carried outdoors in accordance with the provisions approved by the agent.

These machines must be turned off at the end of demonstrations.

Within the Centre de Congrès Pierre Baudis, the fuel tanks for petrol operated vehicles must be empty. If these are not equipped with an anti theft cap, an adhesive tape strip must be fitted to prevent opening.

Alarm systems must be turned off.

Batteries must be disconnected and their lugs made inaccessible.

The floors must be protected

1.4.2 Radioactive substances / x-rays

When showing machines or equipment using radioactive substances or generating x-rays, a special authorisation request must be submitted by the exhibitor to the competent administration.

The stipulations of article T43 of the safety regulations must be observed.

The stands on which radioactive substances are present must be built and decorated using category M1 materials.

Authorisation to present devices emitting x-rays on the stands can only be granted if these are fully compliant with the rules and appurtenances established by standard NF C 74.100.

1.4.3 Forbidden equipment, chemicals and gases

The following are forbidden within the Centre de congrès Pierre Baudis :

- ° the distribution of samples or products containing a flammable gas.
- ° balloons inflated with a flammable or toxic gas.
- ° celluloid items
- ° fireworks and explosives
- ° the presence of diethyl ether, carbon disulphide, sulphuric ether and acetone.

AUTHORIZATION FORM

(This form is to be completed when displaying operating machines; it has to be sent to the organizer at the latest 30 days prior to the beginning of the event)

Fair or exhibition:

Location:

Stand Number:

Exhibitor's corporate name:

Address:

Person in charge of stand:

Phone Number:Fax Number:

SPECIFIC RECOMMENDATIONS

Electrical energy source over 100 KVA
Power used:

Inflammable liquids (others than car tank liquids):
Nature:
Use:

HAZARDS REQUIRING AN APPLICATION TO EXHIBIT AND PRELIMINARY AUTHORIZATION

If you plan to use any material or equipment listed below, please refer to the relevant section in the document entitled « specifications »

Thermal or combustion engine.....

Smoke generator:

Liquid gases (Acetylene, oxygen, hydrogen or any other hazardous gas)
Nature :

Radioactive source:

X-Ray source.....

Laser:

NOTA: The exhibitor will be informed of the final decision concerning the application to exhibit by the organizer.

TYPE OF OPERATING APPLIANCE OR DEVICE ON DISPLAY

.....
CAUTION: The operating equipment or appliances on display must be fitted with the appropriate screens or cases to protect the public from any hazard or must be installed so that the dangerous parts are out of reach or at least at one meter distance from the passageways.

The demonstrations are the sole responsibility of the exhibitor

Date :Signature :